

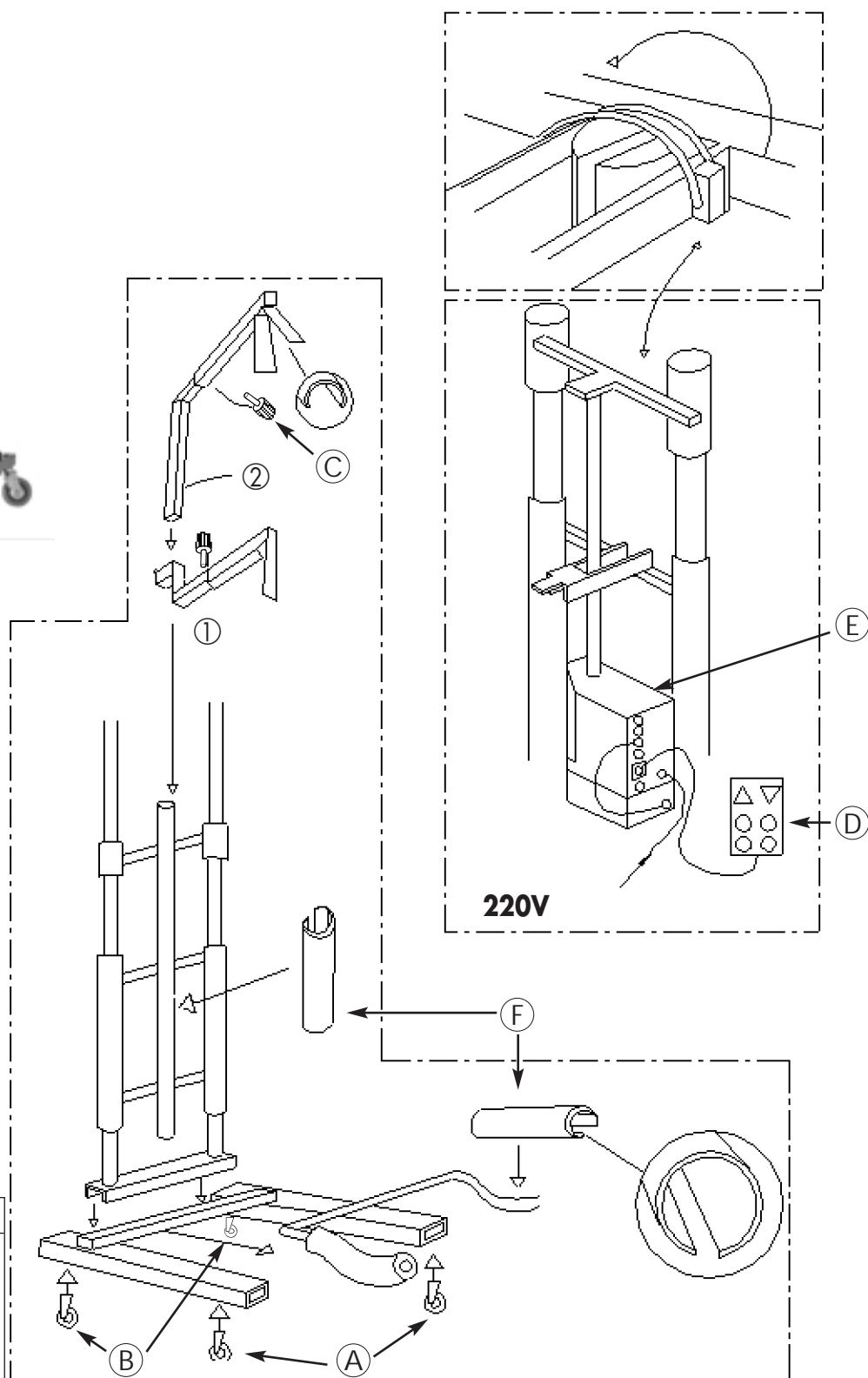







CR.S5



♂		
A	CR.S501	
B	CR.S502	
C	CR.S5-04	(4) 
D	CR.S5-TEL	
E	CR.S5-MOT	
F	CR.S7PRO	



NU-CR.S5/0403