

# NM.1000

☐ 1"=25,4mm

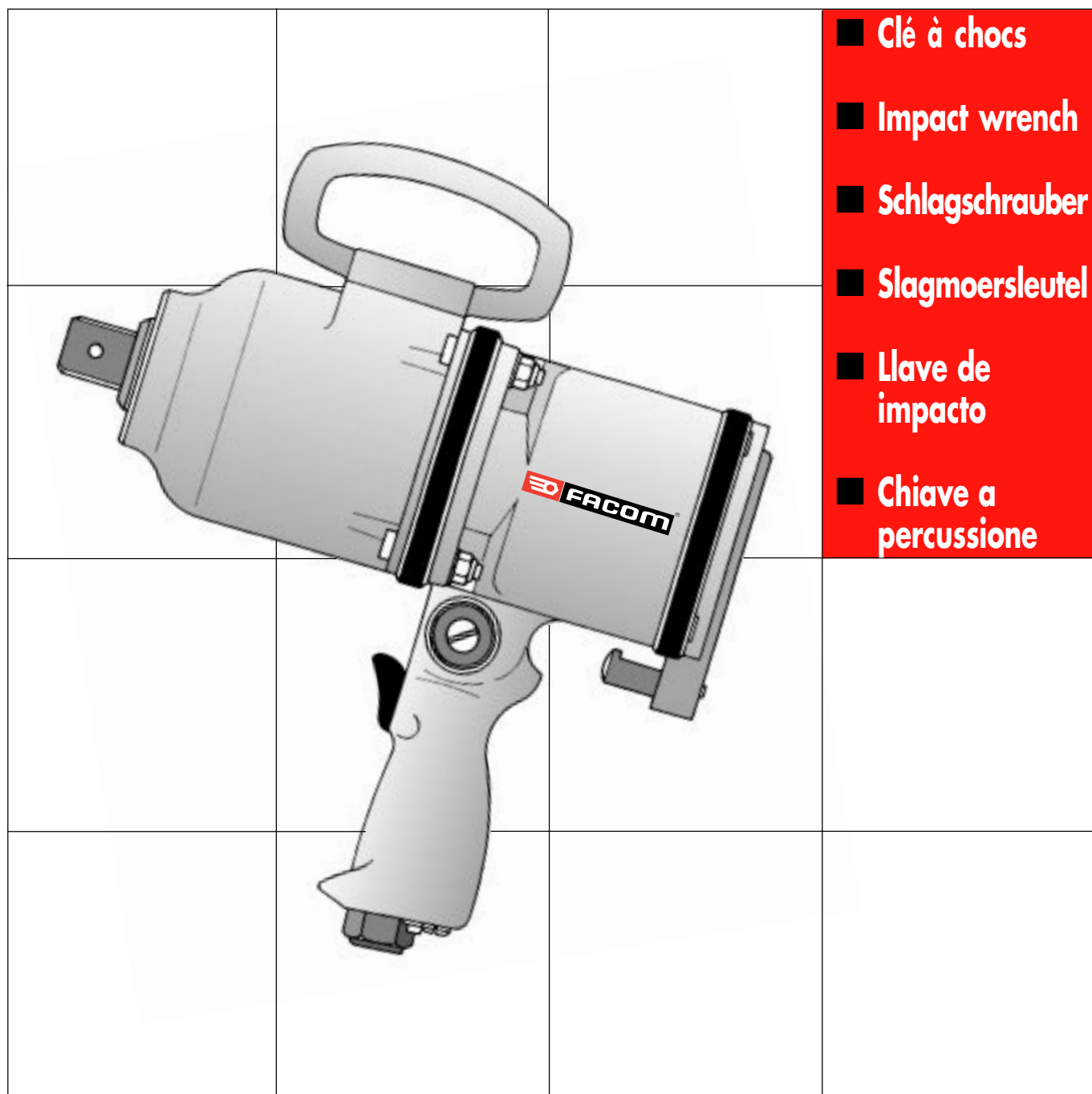

- Clé à chocs
- Impact wrench
- Schlagschrauber
- Slagmoersleutel
- Llave de impacto
- Chiave a percussione

Notice d'instructions  
Instruction manual  
Bedienungsanleitung  
Gebruiksaanwijzing  
Guia de instrucciones  
Istruzioni per l'utilizzo  
**NU-NM.1000/97**



11,0 kg

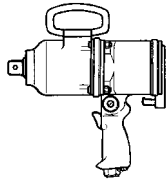

1"

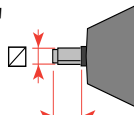

27,6 mm

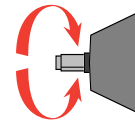

maxi 3500 t/mn

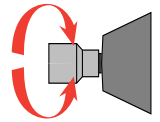

maxi 1800 Nm



3/8 NPT

Ø13 mini

800 l/mn

7 - 10 bar

1"

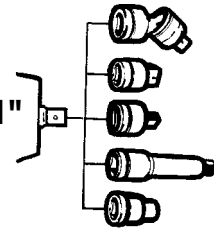

NM.240

NM.230 (1" -3/4")

NM.231 (1" -3/4")

NM.232 (1" - 1 1/2)

NM.209/210/215

NM.21-----77

NM.15/16-----2"1/8

NM.21L-----70L

NM.15/16L-----2"1/8L

NMB.22-----50

NM.27EL-----36EL

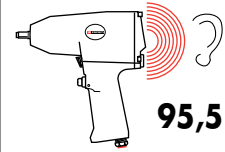

95,5 dB(A)

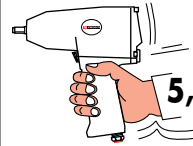

5,62 m/s2



Inverseur  
Reverser  
Umschalter  
Omkeerschakelaar  
Engranaje inversor  
Invertitore

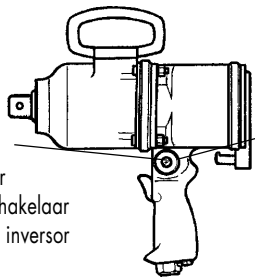

780 Nm

1800 Nm

NM.1000

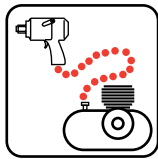
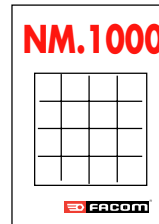

15 bar maxi/20°C  
10 bar maxi/60°C  
1 m3/mn mini

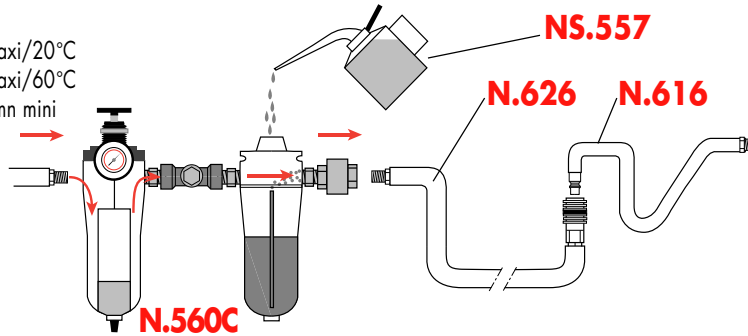

NS.557

N.626

N.616

N.560C

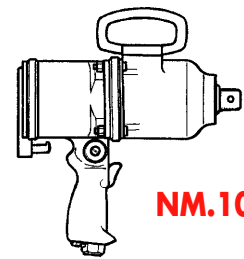

NM.1000

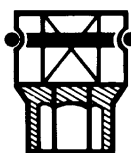

GA.38 + BA.38  
GA.40 + BA.40

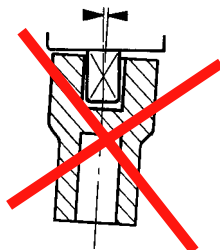

MINI 1800 Nm



Porter des lunettes de sécurité  
Wear eye protectors  
Schutzbrille tragen  
Een veiligheidsbril dragen  
Utilizar gafas de seguridad  
Portare gli occhiali di sicurezza

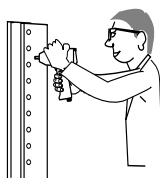

Pour garder la machine en bon état, remplacer les pièces d'usure toutes les 200 heures d'utilisation.

To keep the machine in proper working order, change wear parts after 200 hours of use.

Um die Maschine in gutem Zustand zu erhalten, Gebrauchsteile alle 200 Betriebsstunden austauschen.

Om deze machine in goede staat te houden, dienen de aan slijtage onderhevige onderdelen na 200 uren gebruik te worden vervisseld.

Para mantener la maquina en buen estado, cambiar las piezas de desgaste despues de 200 horas de utilizacion.

Per mantenere la macchina in buono stato, cambiare le parti d'usura dopo 200 ore di funzionamento.

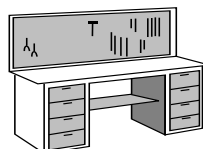

NM.1000RN1

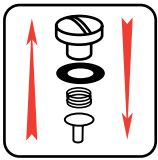

**NM.1000RN1**

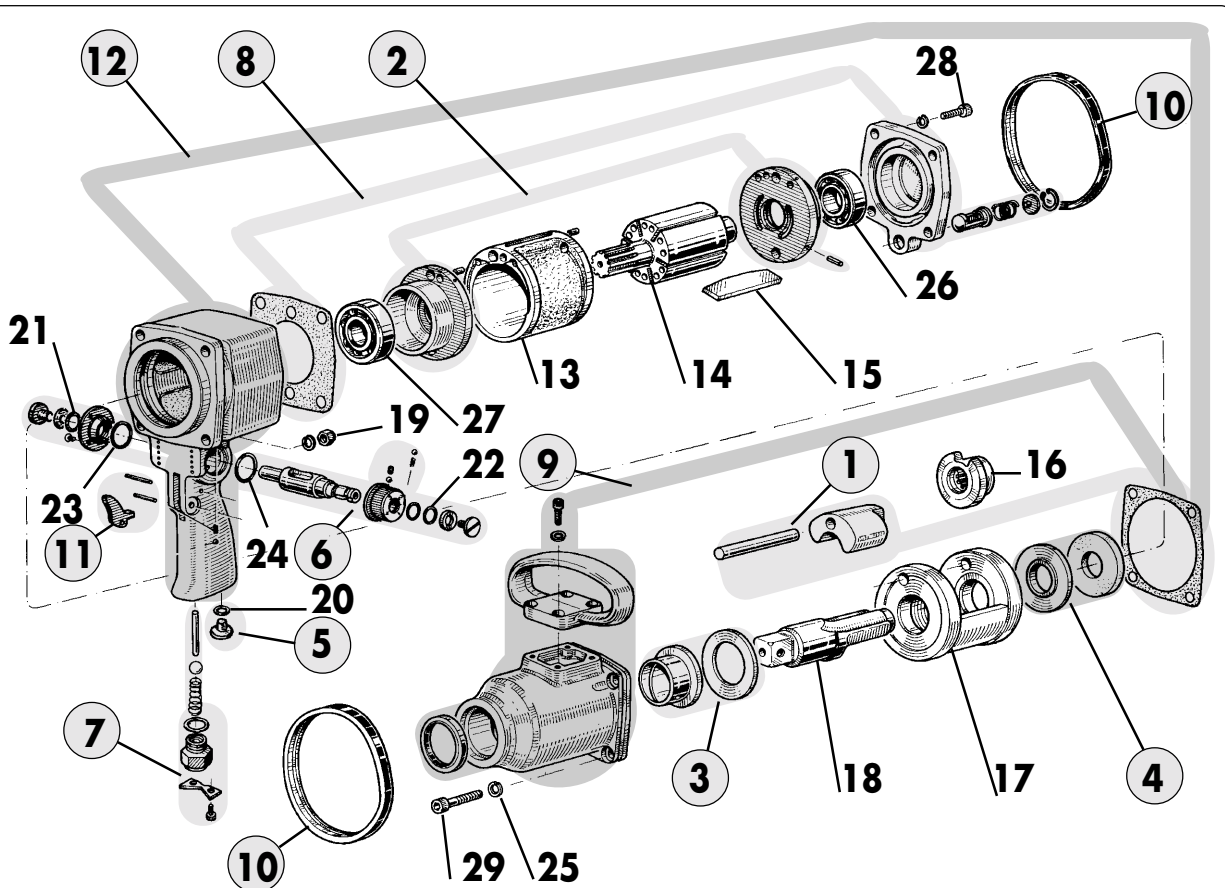
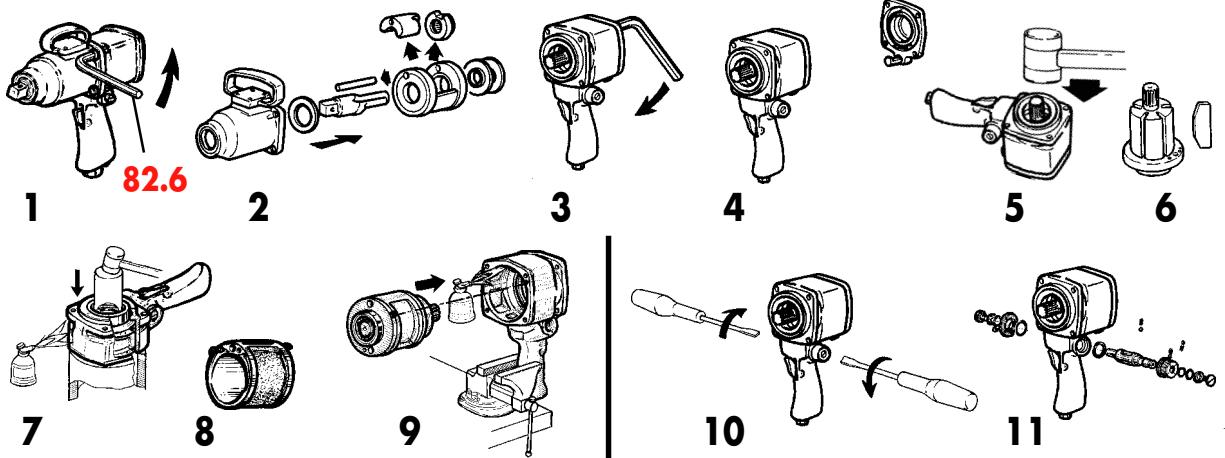
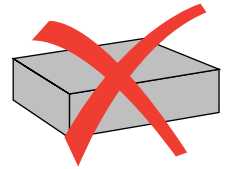

N°	NM.1000	N°	NM.1000	N°	NM.1000
①	NM.1000RN1	⑪	NM.1000SE10	21	BAGUE.R01160-240 (2)
②	NM.1000SE1	⑫	NM.1000SE11	22	BAGUE.R01400-250
③	NM.1000SE2	13	NM.1000-041	23	BAGUE.R01800-250 (2)
④	NM.1000SE3	14	NM.1000-044	24	BAGUE.R02000-250
⑤	NM.1000SE4	15	NM.1000-046J5	25	ROUD. WZ8 (12)
⑥	NM.1000SE5	16	NM.1000-054	26	ROULEMENT.6205
⑦	NM.1000SE6	17	NM.1000-055	27	ROULEMENT.6305
⑧	NM.1200SE7	18	NM.1000-059	28	VIS.CHC,M8-20 (4)
⑨	NM.1000SE8	19	ECROU.HM8 (4)	29	VIS.CHC,M8-35 (4)
⑩	NM.1000SE9	20	BAGUE.R01000-178		



**UNITED  
KINGDOM  
& IRE**

FACOM Tools LTD  
Bridge Wharf - Bridge Road  
CHERTSEY - SURREY KT16-8LJ  
UNITED KINGDOM  
☎ : (01932) 566099  
Fax : (01932) 562653

**BELGIQUE  
BELGIE**

FACOM Belgique S.A./NV  
Weihoek 4  
1930 Zaventem  
BELGIQUE  
☎ : (02) 714 09 00  
Fax: (02) 721 24 11

**DEUTSCHLAND**

FACOM GmbH  
Postfach 13 22 06   
42049 Wuppertal  
Otto-Wells-Straße 9   
42111 Wuppertal  
DEUTSCHLAND  
☎ : (0202) 270 63 0  
Fax : (0202) 270 63 50

**SUISSE  
SCHWEIZ  
AUSTRIA**

FACOM S.A./AG  
12 route Henri-Stéphan  
1762 Givisiez/Fribourg  
SUISSE  
☎ : (4126) 466 42 42  
Fax: (4126) 466 38 54

**NEDERLAND**

FACOM Gereedschappen BV  
Kamerlingh Onnesweg 2  
Postbus 134  
4130 EC Vianen  
NEDERLAND  
☎ : (0347) 372334  
Fax : (0347) 376020

**UNITED  
STATES**

FACOM TOOLS Inc.  
3535 West 47th Street  
Chicago Illinois 60632  
U.S.A.  
☎ : (773) 523 1307  
Fax: (773) 523 2103

**ESPAÑA  
PORTUGAL**

FACOM Herramientas SRL  
Poligono industrial de Vallecas  
C/.Luis 1º, s/n-Nave 95 - 2ºPl.  
28031 Madrid  
ESPAÑA  
☎ : (91) 778 21 13  
Fax: (91) 778 27 53

**SINGAPORE  
FAR EAST**

FACOM Tools FAR EAST Pte Ltd  
15 Scotts Road  
Thong Teck Building #08.01.02  
Singapore 228218  
SINGAPORE  
☎ : (65) 732 0552  
Fax: (65) 732 5609

**ITALIA**

U.A. FACOM Italia  
Via Ronchetti 3  
21041 Albizzate (VA)  
ITALIA  
☎ : (0331) 985811  
Fax: (0331) 985930

**FRANCE**

Société FACOM  
6-8, rue Gustave Eiffel  
B.P.99  
91423 Morangis cedex  
FRANCE  
☎ : 01 64 54 45 45  
Fax: 01 69 09 60 93  
<http://www.facom.fr>

