

**BELGIQUE/LUXEMBOURG**

FACOM Belgique S.A./NV  
 Weihoek 4 1930 Zaventem  
 BELGIQUE  
 ☎ : (02) 714 09 00  
 Fax : (02) 721 24 11

**DANMARK/FINLAND  
 ISLAND/NORGE  
 SVERIGE**

FACOM NORDEN A/S  
 Navervej 16B  
 7451 Sunds  
 DANMARK  
 ☎ : (45) 971 444 55  
 Fax : (45) 971 444 66

**DEUTSCHLAND**

FACOM GmbH  
 Postfach 13 22 06  
 42049 Wuppertal  
 Otto-Wels-Straße 9  
 42111 Wuppertal  
 DEUTSCHLAND  
 ☎ : (0202) 270 63 0  
 Fax : (0202) 270 63 50

**ESPAÑA/PORTUGAL**

FACOM Herramientas SRL  
 Polig. industrial de Vallecas  
 C.Luis 1º, s/n-Nave 95 - 2ºPl.  
 28031 Madrid  
 ESPAÑA  
 ☎ : (91) 778 21 13  
 Fax : (91) 778 27 53

**ITALIA**

USAG Gruppo FACOM  
 Via Volta 3,  
 21020  
 Monvalle (VA)  
 ITALIA  
 ☎ : (0332) 790 111  
 Fax : (0331) 790 602

**POLSKA**

FACOM Oddział w Warszawie  
 ul. Marconich 9 m.3  
 02-954 Warszawa  
 POLSKA  
 ☎ : (0048 22) 642 71 14  
 Fax : (0048 22) 651 74 69

**NEDERLAND**

FACOM Gereedschappen BV  
 Kamerlingh Onnesweg 2  
 Postbus 134  
 4130 EC Vianen  
 NEDERLAND  
 ☎ : (0347) 362362  
 Fax : (0347) 376020

**SINGAPORE/FAR EAST**

FACOM Tools FAR EAST Pte.Ltd  
 15 Scotts Road  
 Thong Teck Building # 08.01.02  
 Singapore 228218  
 SINGAPORE  
 ☎ : (65) 732 0552  
 Fax : (65) 732 5609

**SUISSE/ÖSTERREICH  
 MAGYARORSZAG  
 CESKA REP.**

FACOM S.A./AG  
 12 route Henri-Stéphane  
 1762 Givisiez/Fribourg  
 SUISSE  
 ☎ : (4126) 466 42 42  
 Fax : (4126) 466 38 54

**UNITED KINGDOM/EIRE**

FACOM -UK  
 Churchbridge Works-Walsall Road  
 CANNOCK STAFFORDSHIRE WS11 3JR  
 UNITED KINGDOM  
 ☎ : (01922) 702 150  
 Fax : (01922) 702 152

**UNITED STATES**

FACOM TOOLS Inc.  
 3535 West 47th Street  
 Chicago Illinois 60632  
 U.S.A.  
 ☎ : (773) 523 1307  
 Fax : (773) 523 2103

**FRANCE ET INTERNATIONAL**

Société FACOM  
 6-8, rue Gustave Eiffel B.P.99  
 91423 Morangis cedex  
 FRANCE  
 ☎ : 01 64 54 45 45  
 Fax : 01 69 09 60 93  
<http://www.facom.fr>

**U.306A140 - U.306-180  
 U.306-260 - U.306A130N  
 U.306-170N - U.310-170  
 U.310-250 - U.310-250VH  
 U.310-230N**

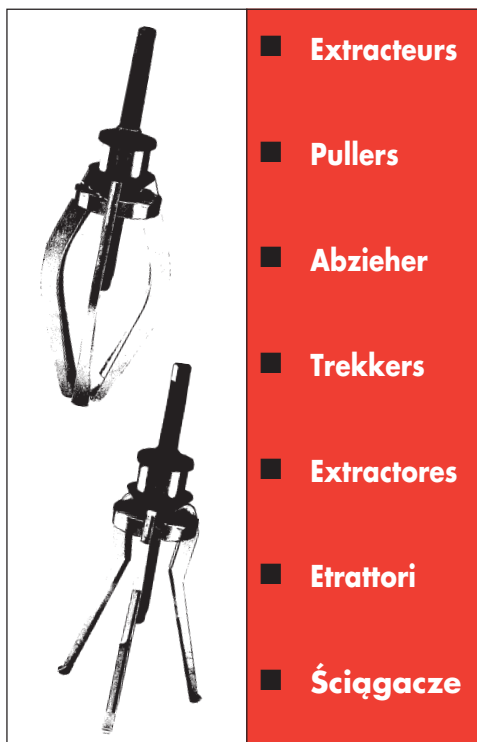
■ **Extracteurs**■ **Pullers**■ **Abzieher**■ **Trekkers**■ **Extractores**■ **Etrattori**■ **Ściągacze**

Notice d'instructions  
 Instruction manual  
 Bedienungsanleitung  
 Gebruiksaanwijzing  
 Guia de instrucciones  
 Istruzioni per l'utilizzo  
 Instrukcja obsługi  
**NU-U.306A/0901**



Utilisation - Use - Gebrauch - Gebruik - Utilizacion - Uso - Użytkowanie

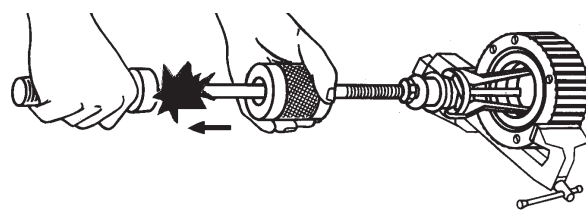
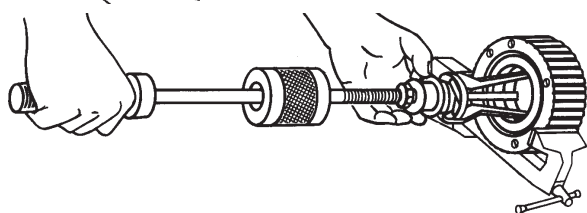
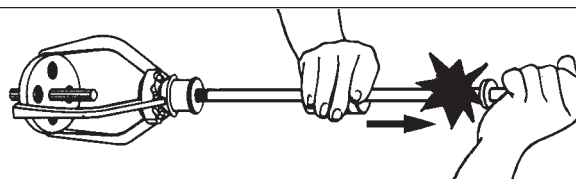
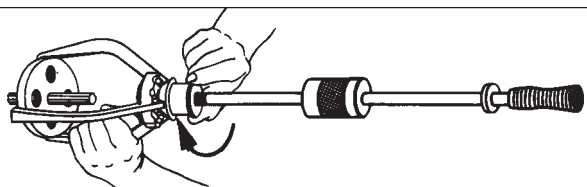
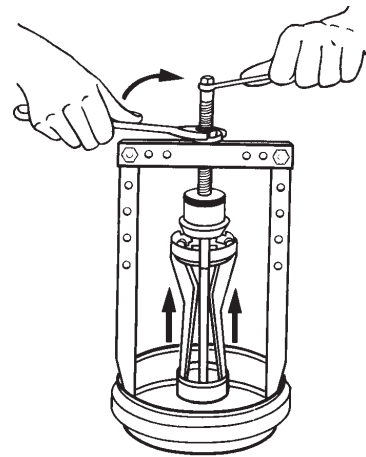
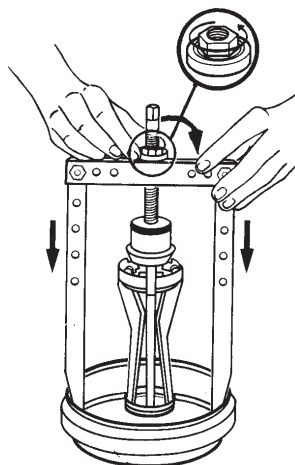
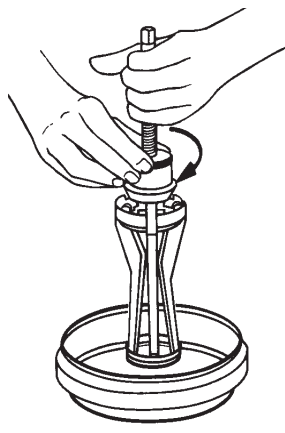
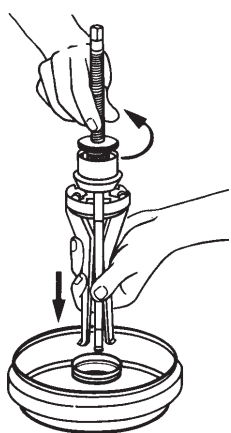
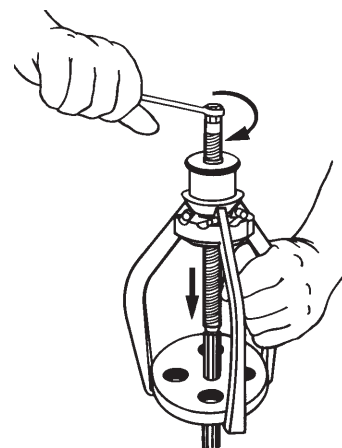
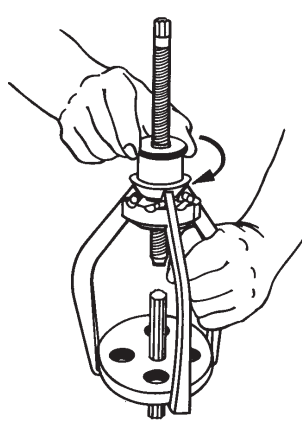
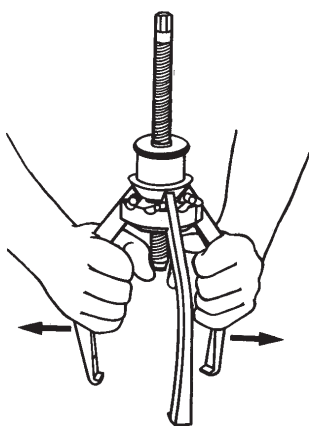
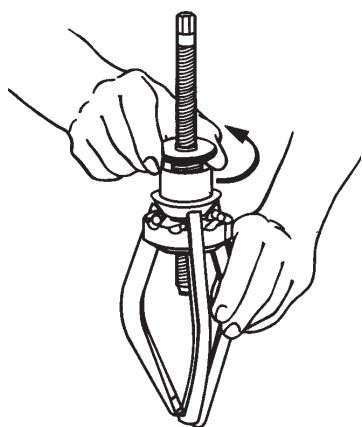
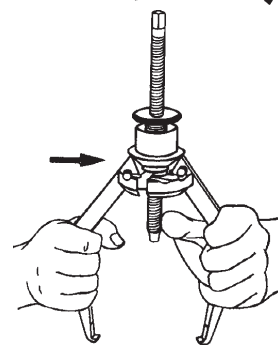
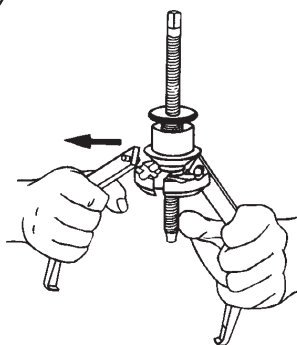
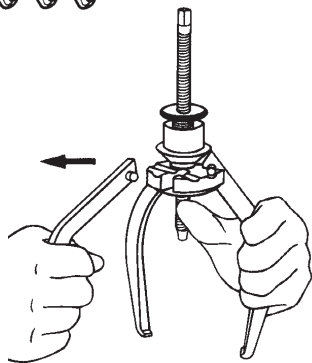
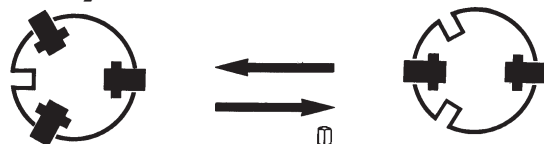

U.306-2 - U.306-4

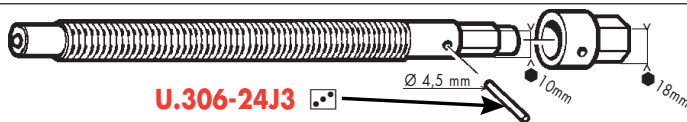



U.306-24J3

130 Nm maxi

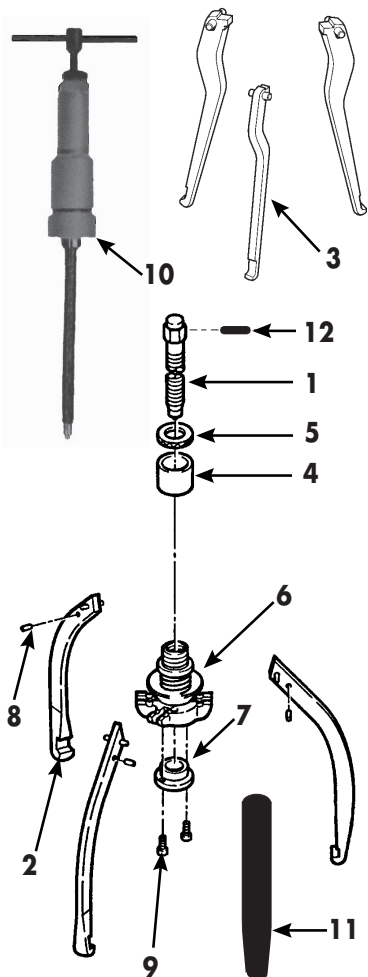
**Caractéristiques - Specifications - Kenndaten - Specificaties - Caracteristicas - Caratteristiche - Dane techniczne**

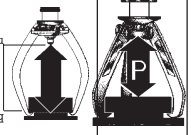

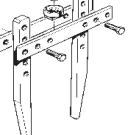
	Ø mini	Ø maxi	Ø mini	Ø maxi				
	mm	mm	mm	mm				
<b>U.306A140</b>	7	140			147	3	U.306M	U.40+U.306A1
<b>U.306-180</b>	10	180			200	4	U.306M	U.40+U.306A1
<b>U.306-260</b>	20	260			250	4	U.306M	U.40+U.306A1
<b>U.306A130N</b>			23	130	140	3	U.306M	U.40+U.306A1
<b>U.306-170N</b>			50	170	190	3	U.306M	U.40+U.306A1
<b>U.310-170</b>	15	170			170	10	U.2	
<b>U.310-250</b>	15	250			250	10	U.2	
<b>U.310-250VH</b>	15	250			250	10	U.2	
<b>U.310-230N</b>			50	230	200	10	U.2	

**Pièces détachées - Spare parts - Ersatzteile - Onderdelen-lijst  
Piezas de recambios - Pezzi di ricambio - Części zamienne**

N°	<b>U.306A140</b>	<b>U.306-180</b>	<b>U.306-260</b>	<b>U.306A130N</b>	<b>U.306-170N</b>	<b>U.310-170</b>	<b>U.306-250</b>	<b>U.306-250VH</b>	<b>U.310-230N</b>
1	U.306-4	U.306-2	U.306-2	U.306-4	U.306-2	U.20B1	U.310-250-10		U.20B1
2	U.306G1 (3)	U.306G10 (3)	U.306G15 (3)			U.310G1 (3)	U.310G2 (3)	U.310G2 (3)	
3				U.306G2 (3)	U.306G20 (3)				U.310G3 (3)
4	U.306-06	U.306-06	U.306-06	U.306-06	U.306-06	U.310-250-06	U.310-250-06	U.310-250-06	U.310-250-06
5	U.306-140-07	U.306-140-07	U.306-140-07	U.306-140-07	U.306-140-07	U.310-170-07	U.310-170-07	U.310-170-07	U.310-170-07
6	U.306-19	U.306-19	U.306-19	U.306-19	U.306-19	U.310-19	U.310-19	U.310-19	U.310-19
7						U.310-170-08	U.310-170-08	U.310-170-08	U.310-170-08
8						U.310GP1 (3)	U.310GP1 (3)	U.310GP1 (3)	U.310GP1 (3)
9						VIS.CHC,M6-16(2)	VIS.CHC,M6-16(2)	VIS.CHC,M6-16(2)	VIS.CHC,M6-16(2)
10								U.3	
11			U.306-3-03						
12	U.306-24J3	U.306-24J3	U.306-24J3	U.306-24J3	U.306-24J3				