

**UNITED KINGDOM  
& IRE**

FACOM Tools LTD  
Bridge Wharf - Bridge Road  
CHERTSEY - SURREY KT16 8UJ  
GREAT BRITAIN  
☎ : (01932) 566099  
Fax : (01932) 562653

**DEUTSCHLAND**

FACOM GmbH  
Postfach 13 22 06  
42049 Wuppertal  
Otto-Wels-Straße 9  
42111 Wuppertal  
DEUTSCHLAND  
☎ : (0202) 704051  
Fax : (0202) 706958

**NEDERLAND**

FACOM Gereedschappen BV  
Kamerlingh Onnesweg 2  
Postbus 134  
4130 EC Vianen  
NEDERLAND  
☎ : (0347) 372334  
Fax : (0347) 376020

**ESPAÑA/PORTUGAL**

FACOM Herramientas SL  
Polig. industrial de Vallecas  
C/. Luis 1º, s/n-Nave 95-2ºPl.  
28031 Madrid  
ESPAÑA  
☎ : (91) 778 21 13  
Fax : (91) 778 27 53

**ITALIA**

U. A. FACOM Italia  
Via Ronchetti 3  
21041 Albizzate (VA)  
ITALIA  
☎ : (0331) 985811  
Fax : (0331) 985930

**BELGIQUE/BELGIE**

S.A. FACOM N.V.  
Weihoek 4  
1930 Zaventem  
BELGIQUE  
☎ : (02) 720 92 07  
Fax : (02) 721 24 11

**SUISSE/SCHWEIZ  
& AUSTRIA**

FACOM S.A./AG  
12 route Henri-Stéphan  
1762 Givisiez/Fribourg  
SUISSE  
☎ : (037) 26 42 42  
Fax : (037) 26 38 54

**UNITED STATES**

FACOM TOOLS Inc.  
3535 West 47th Street  
Chicago Illinois 60632  
U.S.A.  
☎ : (312) 523 1307  
Fax : (312) 523 2103

**SINGAPORE**

FACOM Tools FAR EAST Pte.Ltd  
Thon teck Building  
N°08-01/02  
SINGAPORE  
☎ : (65) 732 0552  
Fax : (65) 732 5609

**FRANCE**

Société FACOM  
6-8, rue Gustave Eiffel B.P.99  
91423 Morangis cedex  
FRANCE  
☎ : (1) 6454 4545  
Fax : (1) 6909 6093

**U.306A140 - U.306-180  
U.306-260 - U.306A130N  
U.306-170N - U.310-170  
U.310-250 - U.310-250VH  
U.310-230N**

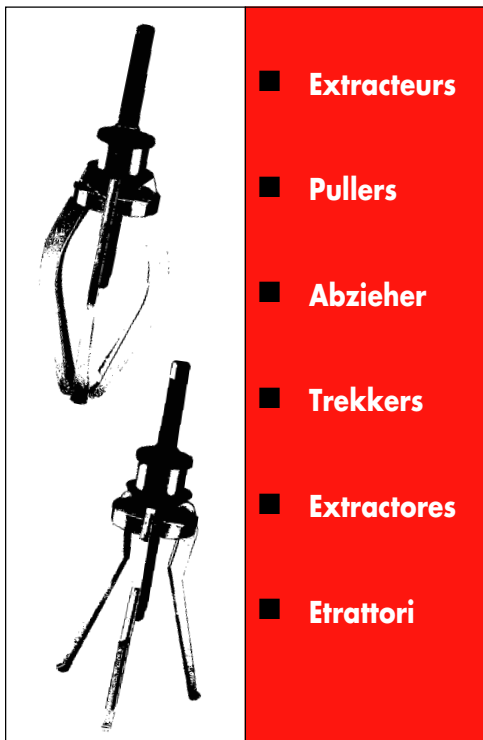

- **Extracteurs**
- **Pullers**
- **Abzieher**
- **Trekkers**
- **Extractores**
- **Etrattori**

Notice d'instructions  
Instruction manual  
Bedienungsanleitung  
Gebruiksaanwijzing  
Guia de instrucciones  
Istruzioni per l'utilizzo  
**NU-U.306A/96**



Utilisation - Use - Gebrauch - Gebruik - Utilizacion - Uso

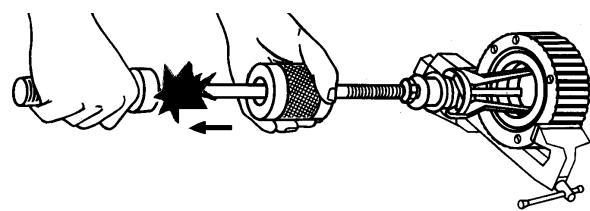
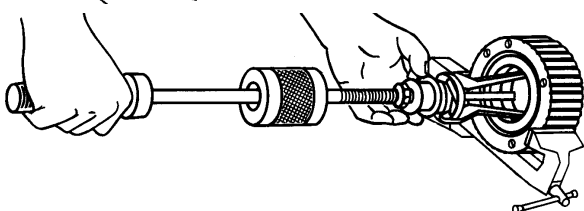
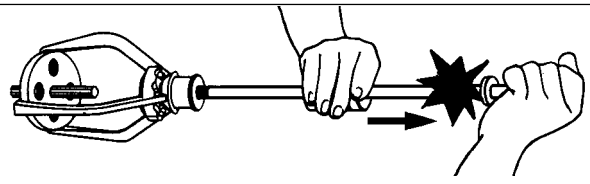
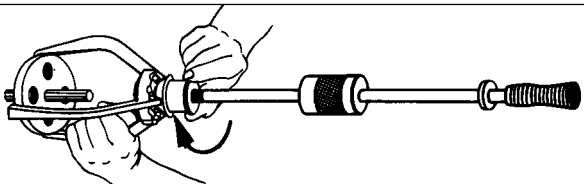
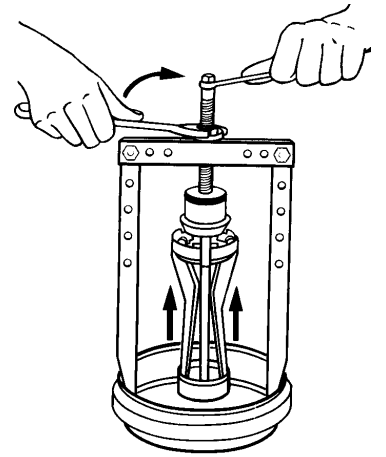
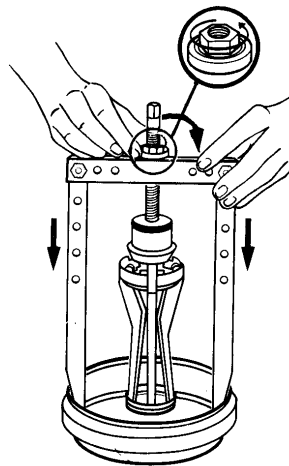
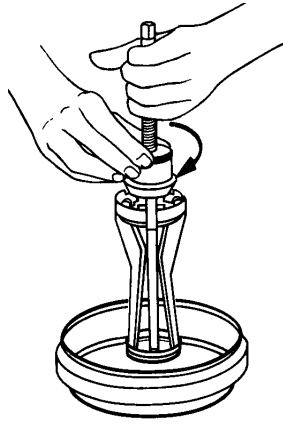
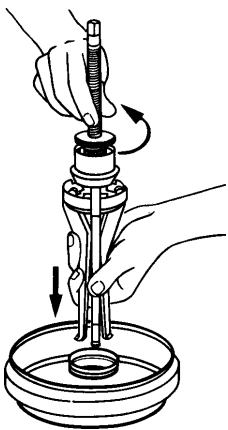
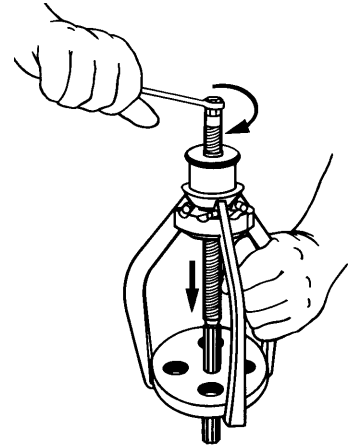
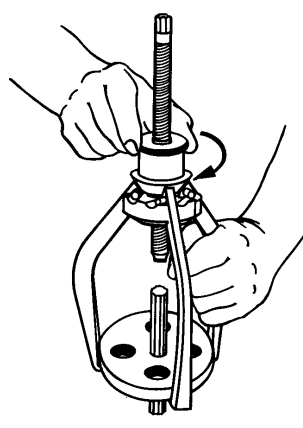
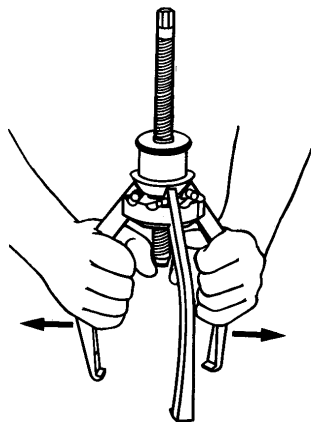
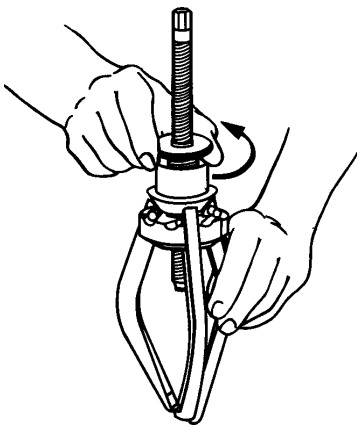
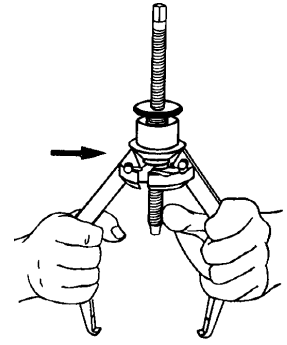
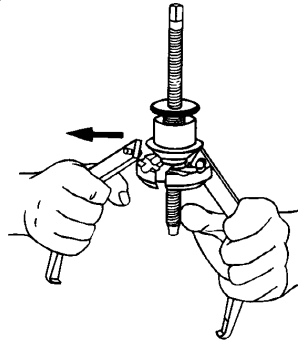
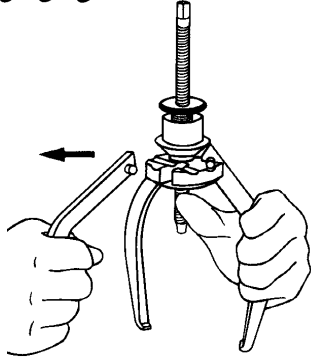
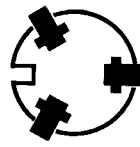

U.306-2 - U.306-4

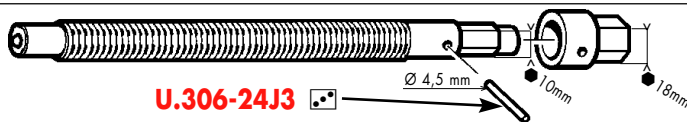



U.306-24J3

130 Nm maxi

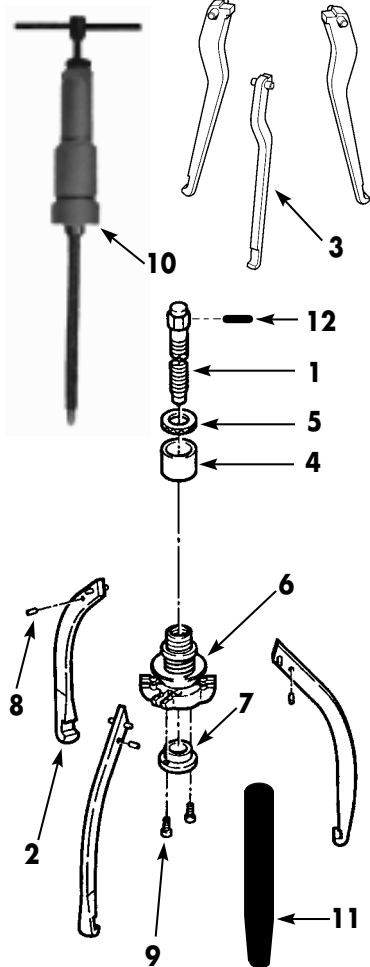
## Caractéristiques - Specifications - Kenndaten - Specificaties - Caracteristicas - Caratteristiche

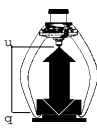

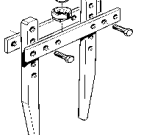
	Ø mini mm	Ø maxi mm	Ø mini mm	Ø maxi mm				
<b>U.306A140</b>	7	140			147	3	U.306M	U.40+U.306A1
<b>U.306-180</b>	10	180			200	4	U.306M	U.40+U.306A1
<b>U.306-260</b>	20	260			250	4	U.306M	U.40+U.306A1
<b>U.306A130N</b>			23	130	140	3	U.306M	U.40+U.306A1
<b>U.306-170N</b>			50	170	190	3	U.306M	U.40+U.306A1
<b>U.310-170</b>	15	170			170	10	U.2	
<b>U.310-250</b>	15	250			250	10	U.2	
<b>U.310-250VH</b>	15	250			250	10	U.2	
<b>U.310-230N</b>			50	230	200	10	U.2	

## Pièces détachées - Spare parts - Ersatzteile

## Onderdelen-lijst - Piezas de recambios - Pezzi di ricambio

N°	U.306A140	U.306-180	U.306-260	U.306A130N	U.306-170N	U.310-170	U.306-250	U.306-250VH	U.310-230N
1	U.306-4	U.306-2	U.306-2	U.306-4	U.306-2	U.20B1	U.310-250-10		U.20B1
2	U.306G1 (3)	U.306G10 (3)	U.306G15 (3)			U.310G1 (3)	U.310G2 (3)	U.310G2 (3)	
3				U.306G2 (3)	U.306G20 (3)				U.310G3 (3)
4	U.306-06	U.306-06	U.306-06	U.306-06	U.306-06	U.310-250-06	U.310-250-06	U.310-250-06	U.310-250-06
5	U.306-140-07	U.306-140-07	U.306-140-07	U.306-140-07	U.306-140-07	U.310-170-07	U.310-170-07	U.310-170-07	U.310-170-07
6	U.306-19	U.306-19	U.306-19	U.306-19	U.306-19	U.310-19	U.310-19	U.310-19	U.310-19
7						U.310-170-08	U.310-170-08	U.310-170-08	U.310-170-08
8						U.310GP1 (3)	U.310GP1 (3)	U.310GP1 (3)	U.310GP1 (3)
9						VIS.CHC,M6-1d(2)	VIS.CHC,M6-1d(2)	VIS.CHC,M6-1d(2)	VIS.CHC,M6-1d(2)
10								U.3	
11			U.306-3-03						
12	U.306-24J3	U.306-24J3	U.306-24J3	U.306-24J3	U.306-24J3				