

V.999A

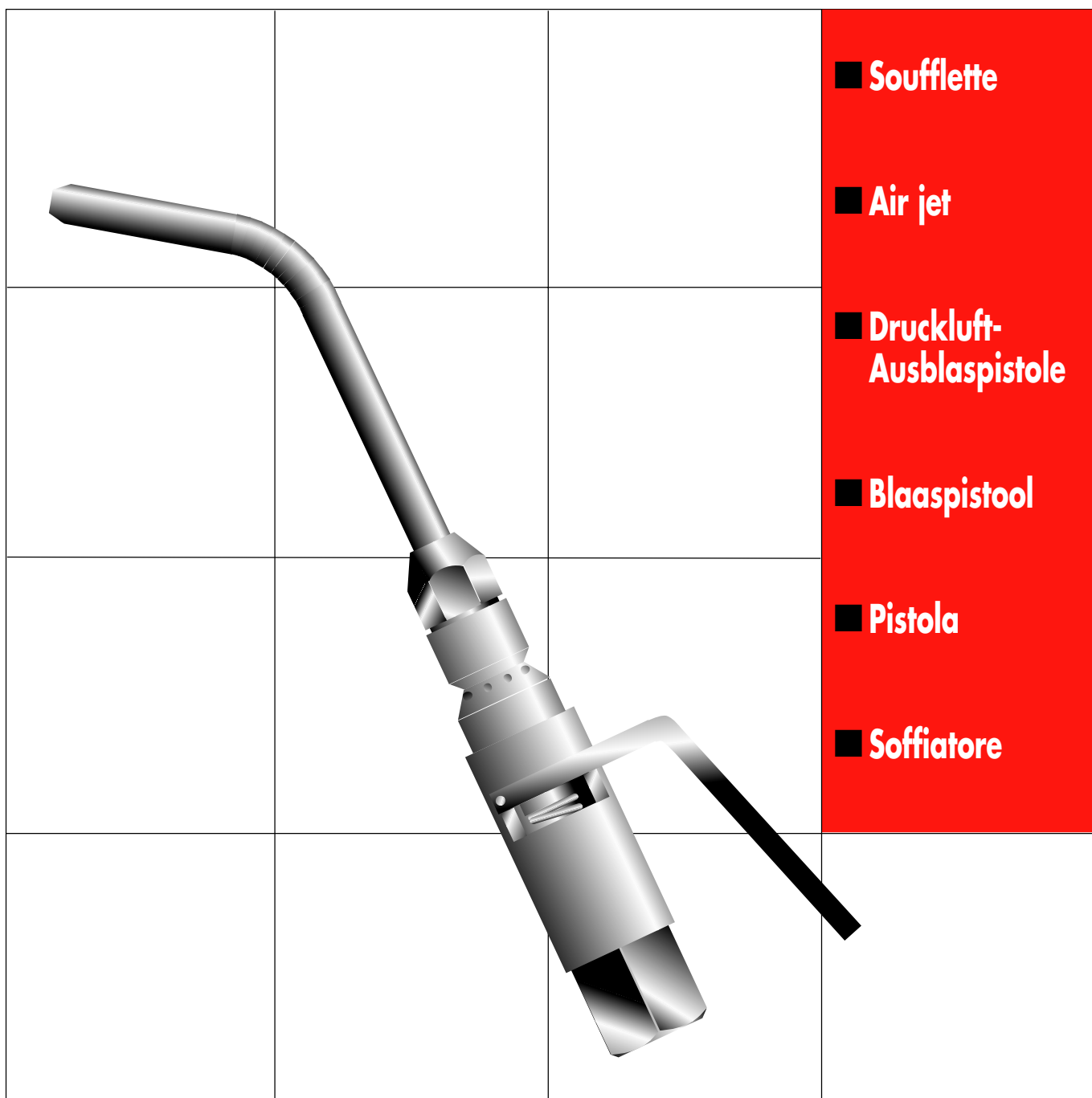

Notice d'instructions
Instruction manual
Bedienungsanleitung
Gebruiksaanwijzing
Guia de instrucciones
Istruzioni per l'utilizzo
NU-V.999A/99



0,170 kg

68

Ø 6

153

2 bars

1/4 NPT

Ø 8 mm

530 l/mn / 2 bars

V.999A10

90

V.999A20

200

V.999A30

300



V.999A

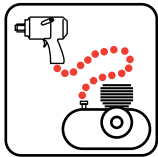

15 bars maxi/20°C
10 bars maxi/60°C
600 m3/mn mini

N.553

N.620

N.610

V.999A



Porter des lunettes de sécurité
Wear eye protectors
Schutzbrille tragen
Een veiligheidsbril dragen
Utilizar gafas de seguridad
Portare gli occhiali di sicurezza



Pour garder la machine en bon état, remplacer les pièces d'usure toutes les 200 heures d'utilisation.
To keep the machine in proper working order, change wear parts after 200 hours to use.
Um die Maschine in gutem Zustand zu erhalten, Gebrauchsteile alle 200 Betriebsstunden austauschen.
Om deze machine in goede staat te houden, dienen de aan slijtage onderhevige onderdelen na 200 uren gebruik te worden verwisseld.
Para mantener la máquina en buen estado, cambiar las piezas de desgaste después de 200 horas de utilización.
Per mantenere la macchina in buono stato, cambiare le parti d'usura dopo 200 ore di funzionamento.

V.999SE1

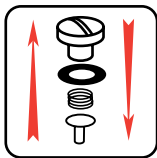

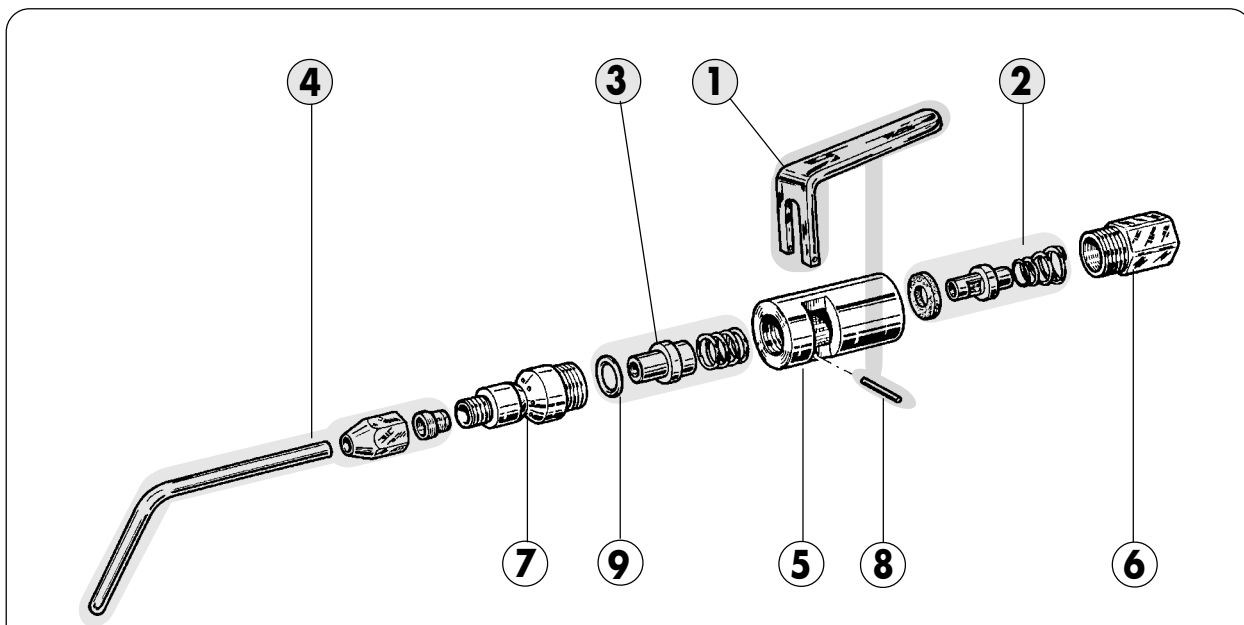
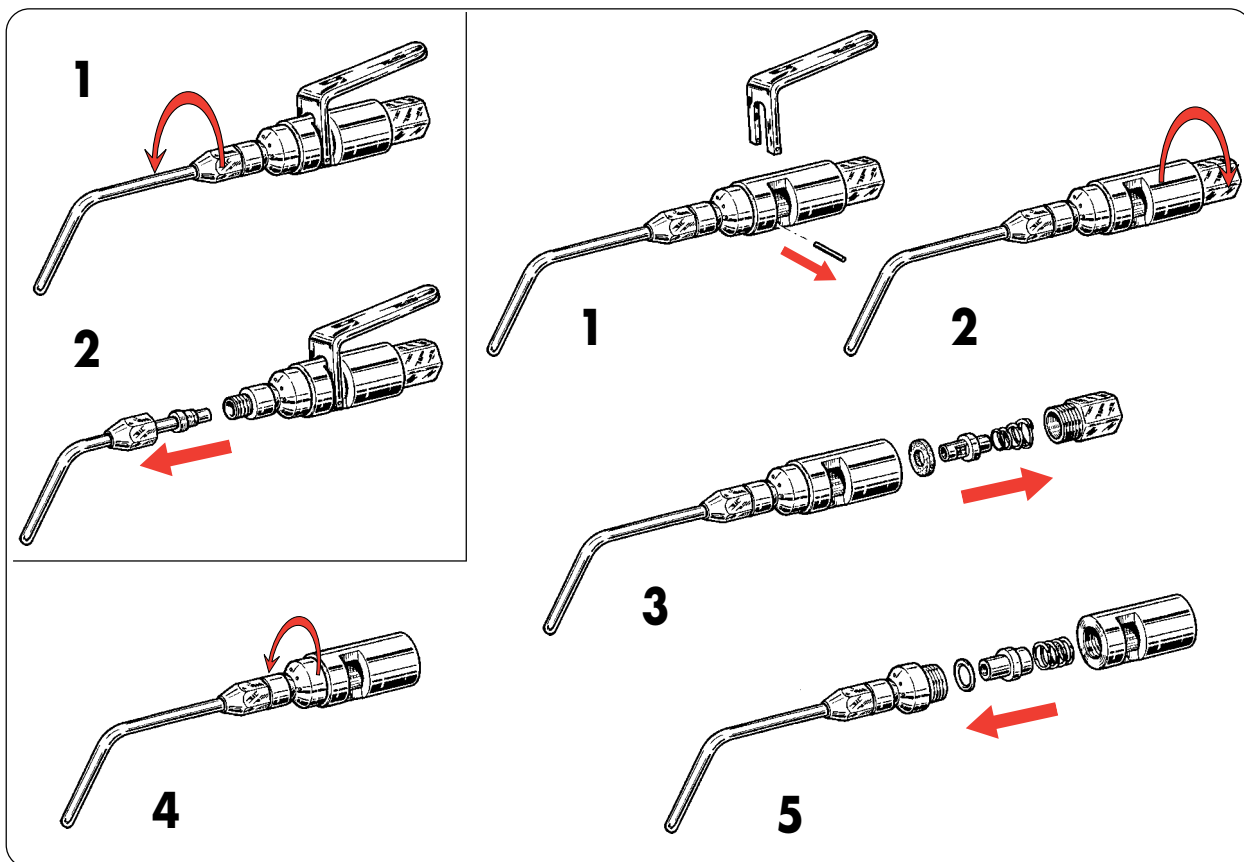
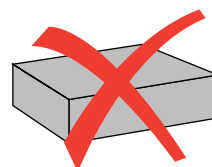

V.999SE1



	V.999A		V.999A
①	V.999SE1	⑥	V.999-003
②	V.999SE2	⑦	V.999A259
③	V.999ASE3	⑧	GOUP.E,1,5-12
④	V.999A10	⑨	BAGUE.RO0710-160
⑤	V.999-001		

**BELGIQUE
LUXEMBOURG** FACOM Belgique S.A/NV
Weihoek 4
1930 Zaventem
BELGIQUE
☎ : (02) 714 09 00
Fax : (02) 721 24 11

**DANMARK
FINLAND
ISLAND
NORGE
SVERIGE** FACOM NORDEN A/S
Navervej 16B
7451 SUNDS
DANMARK
☎ : (45) 971 444 55
Fax : (45) 972 444 66

DEUTSCHLAND FACOM GmbH
Postfach 13 22 06 
42049 Wuppertal
Otto-Wells-Straße 9 
42111 Wuppertal
DEUTSCHLAND
☎ : (0202) 270 63 0
Fax : (0202) 270 63 50

**ESPAÑA
PORTUGAL** FACOM Herramientas SRL
Poligono industrial de Vallecas
C/.Luis 1°, s/n-Nave 95 - 2°Pl.
28031 Madrid
ESPAÑA
☎ : (0034) 91 778 21 13
Fax : (0034) 91 778 27 53

ITALIA USAG Gruppo FACOM
Via Volta 3
21020 Monvalle (VA)
ITALIA
☎ : (0332) 790 111
Fax : (0332) 790 602

NEDERLAND FACOM Gereedschappen BV
Kamerlingh Onnesweg 2
Postbus 134
4130 EC Vianen
NEDERLAND
☎ : (0347) 362 362
Fax : (0347) 376 020

**SINGAPORE
FAR EAST** FACOM Tools FAR EAST Pte Ltd
15 Scotts Road
Thong Teck Building #08.01.02
Singapore 228218
SINGAPORE
☎ : (65) 732 0552
Fax : (65) 732 5609

**SUISSE
ÖSTERREICH
MAGYAROSZAG
ČESKA REP.** FACOM S.A./AG
12 route Henri-Stéphan
1762 Givisiez/Fribourg
SUISSE
☎ : (4126) 466 42 42
Fax : (4126) 466 38 54

**UNITED
KINGDOM
EIRE** FACOM Tools LTD
Bridge Wharf - Bridge Road
CHERTSEY - SURREY KT16-8UJ
UNITED KINGDOM
☎ : (01932) 566 099
Fax : (01932) 562 653

**UNITED
STATES** FACOM TOOLS Inc.
3535 West 47th Street
Chicago Illinois 60632
U.S.A.
☎ : (773) 523 1307
Fax : (773) 523 2103

**FRANCE
&
INTERNATIONAL** Société FACOM
6-8, rue Gustave Eiffel B.P.99
91423 Morangis cedex
FRANCE
☎ : 01 64 54 45 45
Fax : 01 69 09 60 93
http ://www.facom.fr

